

# MB1254

Load Pin

## Content of Loadpin Datasheet

Page 1 ... General

Page 2 ... Mounting Situation

Page 3 ... Output Signal & Wiring

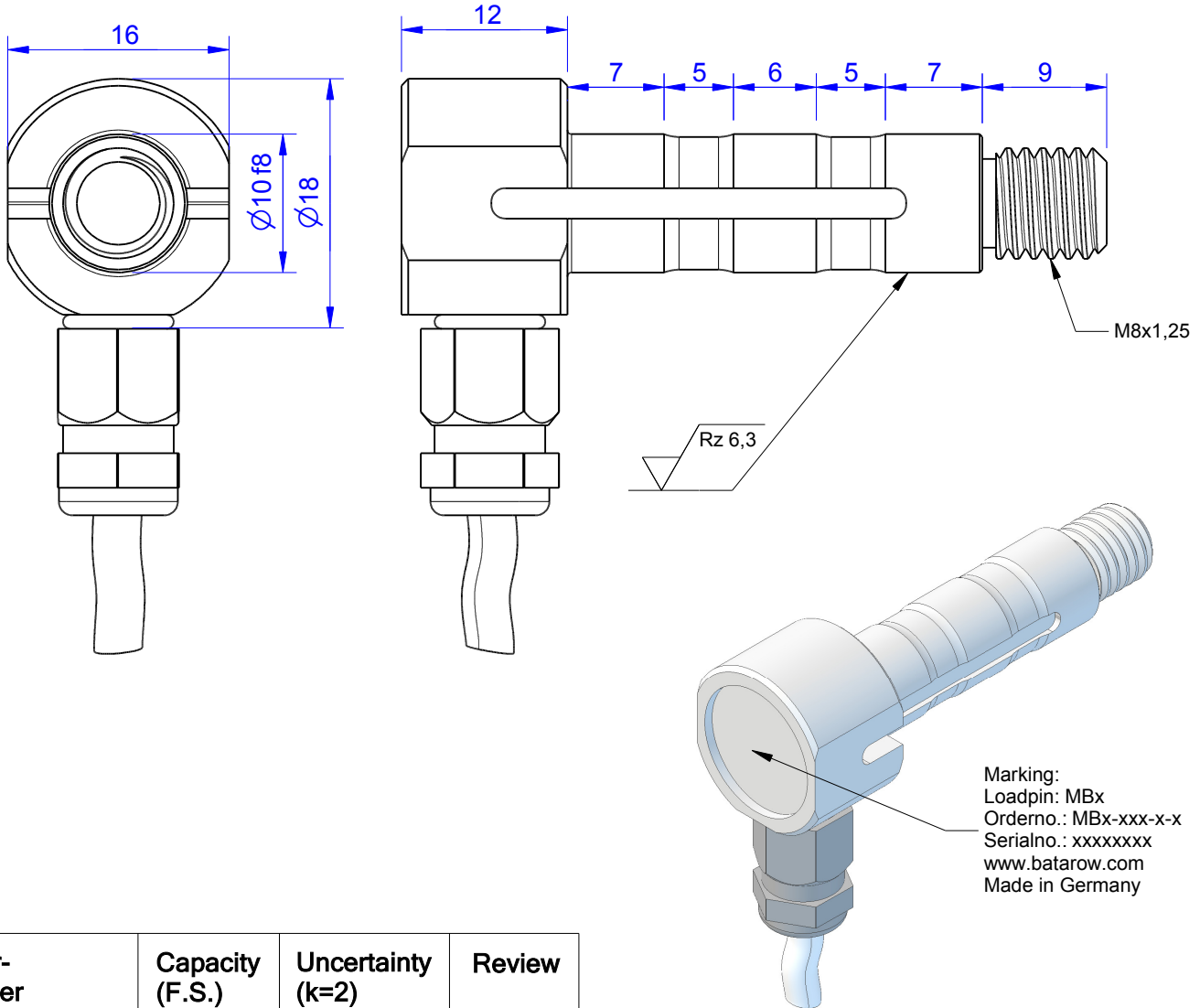

Order-number	Capacity (F.S.)	Uncertainty (k=2)	Review
MB1254-1-x-A	1 kN	±0,005kN	A
MB1254-2-x-A	2 kN	±0,001 kN	A
MB1254-5-x-A	5 kN	±0,025 kN	A
MB1254-10-x-A*	10 kN	±0,05 kN	A

\* above showed version  
The fixed dimensions don't change at the other capacity.

### Specifications:

Dimension / Material		
Material		Stainless Steel
Protection class		IP 65
Hardness (load area)	HRC	40..45
<b>Mechanical Data</b>		
Safe Load Limit	% of F.S.	120
Breaking Load	% of F.S.	200
<b>Precision</b>		
Nonlinearity	% of F.S.	±0,5
Nonrepeatability	% of F.S.	±0,25
Hysteresis	% of F.S.	±0,2
Temp. Shift Zero	% of F.S./K.	±0,05
Temp. Shift Span	% of F.S./K.	±0,05
<b>Temperature</b>		
Compensated Temp.	°C	-10...+60
Operating Temp.	°C	-20...+70

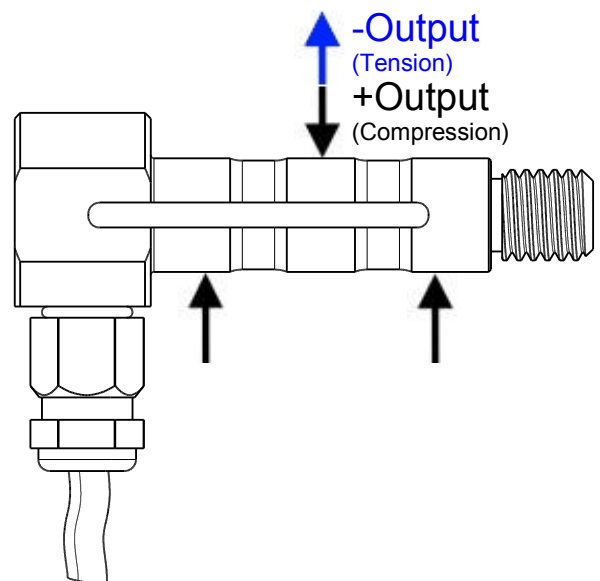

**Batarow**  
Made in Germany

Batarow Sensorik GmbH  
Pappelweg 16  
18276 Lüssow OT Karow

Mail: info@batarow.com  
Phone: +49 (0) 3843-855555  
Fax : +49 (0) 3843-218842

Internet:  
www.batarow.com

# Mounting Situation

MB1254 Review: A

Bore fit of mounting situation: H7

## Configuration

possible mounting situation / customer mounting could vary

(Please describe mounting situation with Vs, Ws, Xs, Ys and Zs for best possible calibration)

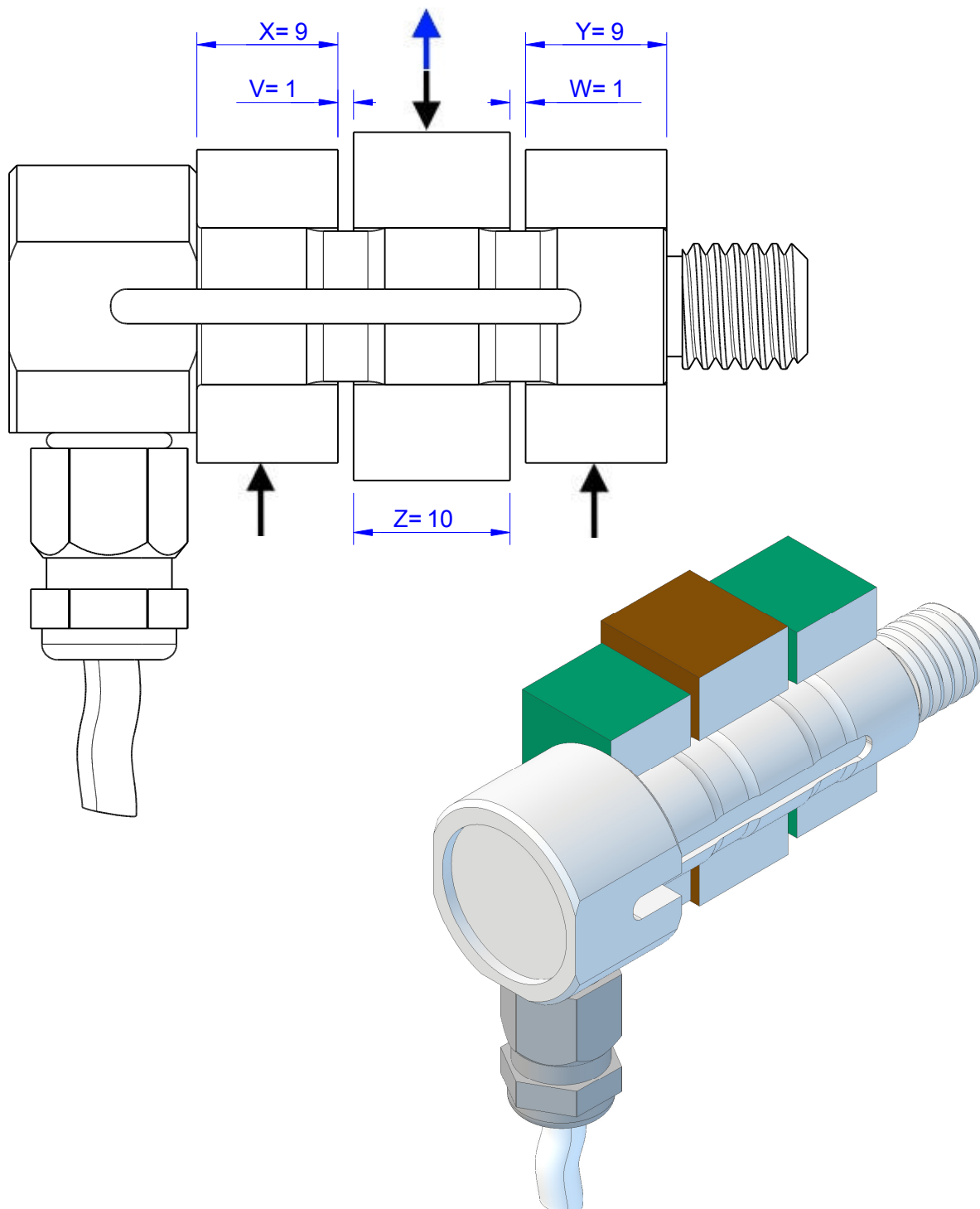

**Batarow**  
Made in Germany

Batarow Sensorik GmbH  
Pappelweg 16  
18276 Lüssow OT Karow

Mail: [info@batarow.com](mailto:info@batarow.com)  
Phone: +49 (0) 3843-855555  
Fax : +49 (0) 3843-218842

Internet:  
[www.batarow.com](http://www.batarow.com)

# Output Signal & Wiring

MB1254 Review: A

## Analog Output mV/V (S1)

Electrical Data		
Rated Output	mV/V@F.S.	1
Zero Balance	mV/V	±0,05
Excitation (Maximum)	Volt	10
Input Resistance	Ohm	450±100
Output Resistance	Ohm	352±2
Insulating Resistance	GOhm	>5

Wiringcode: WC50		Cabletype: stc31v		
Cable Length	Excitation (+)	Excitation (-)	Bridge (+)	Bridge (-)
2 m	red	black	green	white

Ordernumber Add-On:  
MBxxx-x-S1-x

Attention: Nipple orientation of connector is not fixed. In case of 90° connector - it is necessary to set by customer.

\*Attention: With this output configuration is no negative signal (Tension) possible. Please ask our engineering for 4..12..20mA; 1..5..9V or ±10V versions.

**Batarow**  
Made in Germany

Batarow Sensorik GmbH  
Pappelweg 16  
18276 Lüssow OT Karow

Mail: [info@batarow.com](mailto:info@batarow.com)  
Phone: +49 (0) 3843-855555  
Fax : +49 (0) 3843-218842

**Internet:**  
[www.batarow.com](http://www.batarow.com)