

MB323

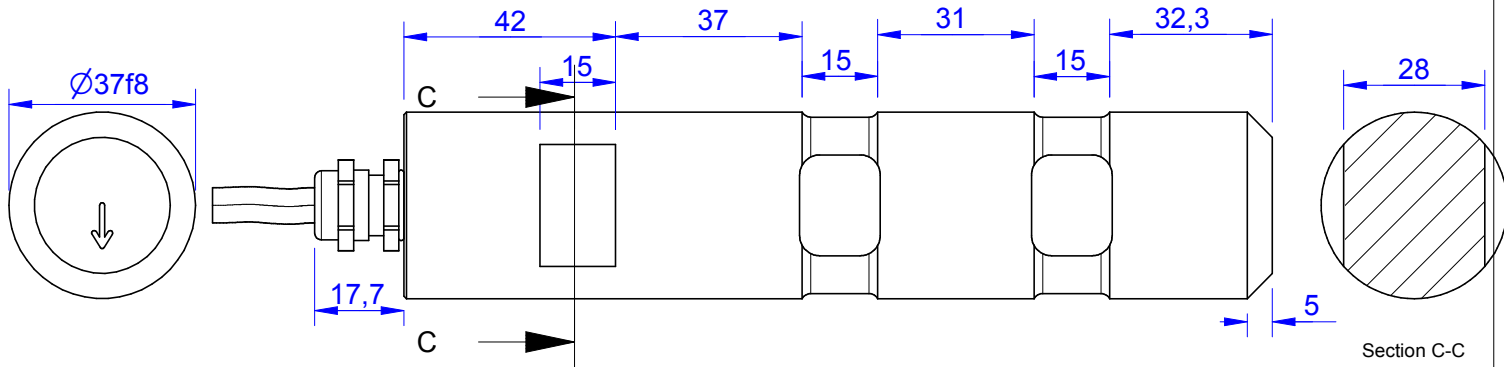

Order no.	Capacity (F.S.)	Review
MB323-10-B	10 kN	B
MB323-20-B	20 kN	B
MB323-50-B	50 kN	B
MB323-90-B*	90 kN	B

* above showed version
The fixed dimensions don't change at the other capacity.

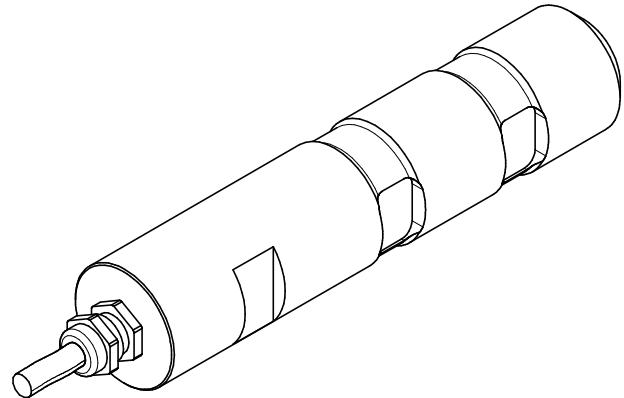

Specifications: (Customizing on request)

Dimension / Material		
Type of Construction		Stainless Steel
Material		IP 68
Protection class		
Mechanical Data		
Safe Load Limit	% of F.S.	150
Breaking Load	% of F.S.	300
Electrical Data		
Output @ 0kN	V	5
Output @ F.S.	V	10
Supply Voltage	V	11..30
Current Consumption	mA	15 (@ 24V)
Switching Output		Open Collector
max. Switching current	mA	100
Precision		
Precisionclass	%	1
Nonlinearity	% of F.S.	±0,5
Nonrepeatability	% of F.S.	±0,25
Hysteresis	% of F.S.	±0,2
Temp. Shift Zero	% of F.S./K.	±0,05
Temp. Shift Span	% of F.S./K.	±0,05
Temperature		
Compensated Temp.	°C	-10...+80
Operating Temp.	°C	-20...+80

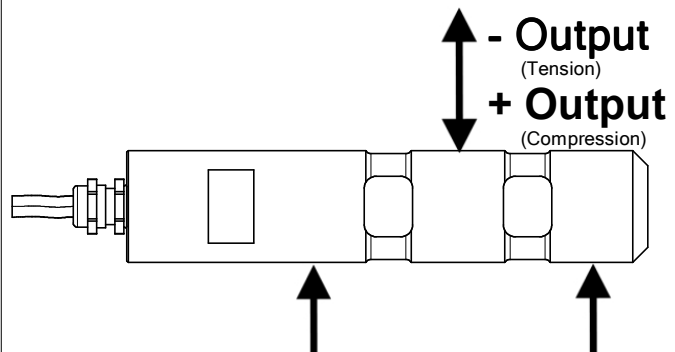

Wiringcode: WC33			
Integrated Amplifier: GSV-15L			
Cabeling: 3m 4x2x0,25 PUR			
Supply(+)	brown	Scale	grey
Ground (-)	white	Threshold	pink
Output	green	Output Ground	blue
Tare	yellow		

Batarow
Made in Germany

Batarow Sensorik GmbH
Karow 17
18276 Lüssow

Mail: info@batarow.com
Phone: +49 (0) 3843-855555
Fax : +49 (0) 3843-218842

Internet:
www.batarow.com

Mounting Situation

MB323 Review: B

Configuration 1 (Standard)

possible Mounting Situation / Customer Mounting could vary

(Please describe Mounting situation with Vs,Ws,Xs,Ys and Zs for best possible calibration)

